

INSTALLATION MANUAL

AIR-TO-WATER HEAT PUMP

Please read this installation manual completely before installing the product.
Installation work must be performed in accordance with the national wiring standards by authorized personnel only.

Please retain this installation manual for future reference after reading it thoroughly

Hydro Kit (For Medium Temperature)

Original instruction

[Representative] LG Electronics Inc. EU Representative : LG Electronics European Shared Service Center B.V. Krijgsman 1, 1186 DM Amstelveen, The Netherlands

[Manufacturer] LG Electronics Inc. Changwon 2nd factory 84, Wanam-ro, Seongsan-gu, Changwon-si, Gyeongsangnam-do, KOREA



MFL67086712



001

www.lg.com

TABLE OF CONTENTS

1. Safety Precautions.....	3
2. Installation Parts.....	7
3. General Information.....	8
Model Information.....	8
General Information.....	9
4. Installation.....	10
Selection of the best location.....	10
Installation Space.....	10
Foundation for Installation.....	11
Water Piping and Water Circuit Connection.....	12
Sanitary Water Tank and Sanitary Water Tank Kit.....	16
Solar Thermal Kit.....	18
Installation Scenes.....	19
Refrigerant Piping.....	22
How to connect wirings.....	25
Wiring Connection.....	25
Connecting Cables.....	27
5. Accessories Installation.....	28
Location of Accessories and External Parts Connection.....	28
Main Pump Connection.....	31
Water tank temperature sensor Connection.....	31
Thermostat.....	32
Remote Temperature Sensor.....	36
3Way Valve.....	37
2Way Valve.....	39
Independent Power Module.....	40
6. System Set-Up.....	42
DIP Switch Setting.....	42
Group Control Setting.....	43
Installer Setting.....	47
7. Test Run.....	59
Caution before Operation Test.....	59
Operation Test of Water Pipe.....	59
Troubleshooting.....	60

1. Safety Precautions



To prevent injury to the user or other people and property damage, the following instructions must be followed.

- Be sure to read before installing the unit.
- Be sure to observe the cautions specified here as they include important items related to safety.
- Incorrect operation due to ignoring instruction will cause harm or damage. The seriousness is classified by the following indications.

⚠ WARNING This symbol indicates the possibility of death or serious injury.

⚠ CAUTION This symbol indicates the possibility of injury or damage to properties only.

- Meanings of symbols used in this manual are as shown below.

	Be sure not to do.
	Be sure to follow the instruction.

⚠ WARNING

Installation

- Do not use a defective or underrated circuit breaker. Use this appliance on a dedicated circuit.
 - There is risk of fire or electric shock.
- For electrical work, contact the dealer, seller, a qualified electrician, or an Authorized Service Center.
 - There is risk of fire or electric shock.
- Always ground the unit.
 - There is risk of fire or electric shock.
- Install the panel and the cover of control box securely.
 - There is risk of fire or electric shock.
- Always install a dedicated circuit and breaker.
 - Improper wiring or installation may cause fire or electric shock.
- Use the correctly rated breaker or fuse.
 - There is risk of fire or electric.
- Do not modify or extend the power cable.
 - There is risk of fire or electric shock.
- Do not install, remove, or reinstall the unit by yourself (customer).
 - There is risk of fire, electric shock, explosion, or injury.

- For antifreeze, always contact the dealer or an authorized service center.
 - Almost the antifreeze is a toxic product.
- The refrigerant of this product is R410A.
 - The installation tool such as manifold gauge should be complied with R410A.
- For installation, always contact the dealer or an Authorized Service Center.
 - There is risk of fire, electric shock, explosion, or injury.
- Do not install the unit on a defective installation stand.
 - It may cause injury, accident, or damage to the unit.
- Be sure the installation area does not deteriorate with age.
 - If the base collapses, the unit could fall with it, causing property damage, unit failure, and personal injury.
- Do not install the unit outdoor.
 - It may cause damage to the unit.
- Use a vacuum pump or inert (nitrogen) gas when doing leakage test or purging air. Do not compress air or oxygen and do not use flammable gases.
 - There is the risk of death, injury, fire or explosion.
- Means for disconnection must be incorporated in the fixed wiring in accordance with the wiring rules.
- This equipment shall be provided with a supply conductor complying with the national regulation.

Operation

- Take care to ensure that power cable could not be pulled out or damaged during operation.
 - There is risk of fire or electric shock.
- Do not place anything on the power cable.
 - There is risk of fire or electric shock.
- Do not plug or unplug the power supply plug during operation.
 - There is risk of fire or electric shock.
- Do not touch (operate) the unit with wet hands.
 - There is risk of fire or electric shock.
- Do not place a heater or other appliances near the power cable.
 - There is risk of fire or electric shock.

- Do not allow water to run into electric parts.
 - There is risk of fire, failure of the unit, or electric shock.
- Do not store or use flammable gas or combustibles near the unit.
 - There is risk of fire or failure of unit.
- Do not use the unit in a tightly closed space for a long time.
 - It may cause damage to the unit.
- When flammable gas leaks, turn off the gas and open a window for ventilation before turning the unit on.
 - There is risk of explosion or fire.
- If strange sounds, or small or smoke comes from unit, turn the breaker off or disconnect the power supply cable.
 - There is risk of electric shock or fire.
- Stop operation and close the window in storm or hurricane. If possible, remove the unit from the window before the hurricane arrives.
 - There is risk of property damage, failure of unit, or electric shock.
- Do not open the front cover of the unit while operation. (Do not touch the electrostatic filter, if the unit is so equipped.)
 - There is risk of physical injury, electric shock, or unit failure.
- When the unit is soaked (flooded or submerged), contact an Authorized Service Center.
 - There is risk of fire or electric shock.
- Be cautious that water could not be poured to the unit directly.
 - There is risk of fire, electric shock, or unit damage.
- Ventilate the unit from time to time when operating it together with a stove, etc.
 - There is risk of fire or electric shock.
- Turn the main power off when cleaning or maintaining the unit.
 - There is risk of electric shock.
- Take care to ensure that nobody could step on or fall onto the unit.
 - This could result in personal injury and unit damage.
- For installation, always contact the dealer or an Authorized Service Center.
 - There is risk of fire, electric shock, explosion, or injury.
- If the unit is not used for long time, we strongly recommend not to switch off the power supply to the unit.
 - There is risk of water freezing.

 **CAUTION**

Installation

- Always check for gas (refrigerant) leakage after installation or repair of unit.
 - Low refrigerant levels may cause failure of unit.
- Keep level even when installing the unit.
 - To avoid vibration or water leakage.
- Use two or more people to lift and transport the unit.
 - Avoid personal injury.



Operation

- Do not lay on the cooled floor for long time when the unit is in cooling operation.
 - This could harm to your health.
- Do not use the unit for special purposes, such as preserving foods, works of art, etc.
 - There is risk of damage or loss of property.
- Use a soft cloth to clean. Do not use harsh detergents, solvents, etc.
 - There is risk of fire, electric shock, or damage to the plastic parts of the unit.
- Do not step on or put anything on the unit.
 - There is risk of personal injury and failure of unit.
- Use a firm stool or ladder when cleaning or maintaining the unit.
 - Be careful and avoid personal injury.
- Do not unplug the power supply plug of Hydro Kit when stopping Hydro Kit operation. Always turn Hydro Kit off, using the wired remote controller.
 - A plate heat exchanger burst may happen because of disconnection of communication between Hydro Kit and the outdoor unit.

2. Installation Parts

Thank you for choosing LG Electronics **Hydro Kit**.

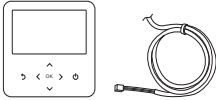
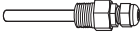
Before starting installation, please make it sure that all parts are found inside the unit box.

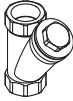
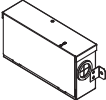
Item	Image	Quantity
Remote Cotroller / Cable		1
Sensor Holder		1
Water Tank Temperature Sensor		1
Strainer		1
Independent Power Module		1

3. General Information

With advanced inverter technology, **Hydro Kit** is suitable for applications like under floor heating, and hot water generation. By Interfacing to various accessories user can customize the range of the application.

Model Information

Model name and related information

Type		Hydro Kit		
HP		10	4	
Power Supply		Ø, V, Hz		
		1, 220-240, 50		
Capacity	Cooling	kW	28	12.3
		kcal/h	24 100	10 580
		Btu/h	95 900	42 000
	Heating	kW	31.5	13.8
		kcal/h	27 100	11 870
		Btu/h	107 500	47 000

*1 : Tested under Eurovent Heating condition (water temperature 30°C(86°F) → 35°C(95°F) at outdoor ambient temperature 7°C(44°F) / 6°C(42°F))

*2 : Tested under Eurovent Cooling condition (water temperature 23°C(73°F) → 18°C(64°F) at outdoor ambient temperature 35°C(95°F) / 24°C(75°F))

- Max Allowable pressure
High side : 4.2 MPa / Low Side : 2.4 MPa
- Max Allowable water temperature
High side : 50°C / Low side : 10°C
- Max Allowable water pressure
0.98 Mpa (0.3~10 kg f/cm²)

General Information

To extend the functionality of **Hydro Kit**, there are various external auxiliary apparatus called as "accessories".

They are classified by "accessories" and "3rd party accessories" according to the manufacturer. Accessories are presented LG Electronics, and 3rd party accessories are presented by related manufacturers.

Accessories supported by LG Electronics

Item	Purpose	Model
Remote Air Sensor	To control the unit by air temperature	PDRYCB000 / PDRYCB100
Dry Contact	To receive on & off external signal	PQDSA
Solar Thermal Kit	To operate with sanitary water tank	PHLLA

Accessories supported by 3rd party Companies

Item	Purpose	Specification
Solar Thermal System	To generate auxiliary heating energy for water tank	
Thermostat	To control the unit by air temperature	Heating-Only type (1~ 230 V or 1~ 24 V) Cooling/Heating type (1~ 230 V or 1~ 24 V AC with Mode selection switch)
3way valve and actuator	To control water flow for hot water heating or floor heating	3 wire, SPDT (Single Pole Double Throw) type, 1~ 230 V
2way valve and actuator	To control water flow for Fan Coil Unit	2wire, NO(Normal Open) or NC (Normal Closed) type, 1~ 230 V

4. Installation

Selection of the best location

1. Select space for installing the unit, which will meet the following conditions:
 - The place where the unit shall be installed inside.
 - The place shall easily bear a load exceeding four times of the unit weight.
 - The place where the unit shall be leveled.
 - The place shall allow easy water drainage.
 - The place where the unit shall be connected to the outdoor unit.
 - The place where the unit is not affected by an electrical noise.
 - The place where there should not be any heat source or steam near the unit.

Installation Space

- The following values are the least space for installation.
If any service area is needed for service according to field circumstance, obtain enough service space.
- The unit of values is mm(inch).

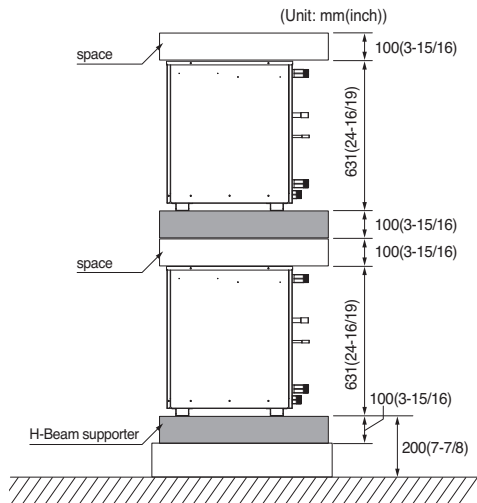
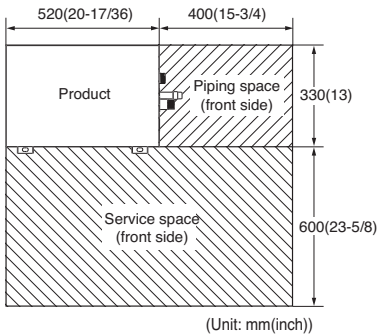

Foundation for Installation

- Fix the unit tightly with bolts as shown below so that the unit will not fall down due to earthquake.
- Noise and vibration may occur from the floor or wall since vibration is transferred through the installation part depending on installation status. Thus, use anti-vibration materials (cushion pad) fully (The base pad shall be more than 200 mm (7-7/8 inch)).

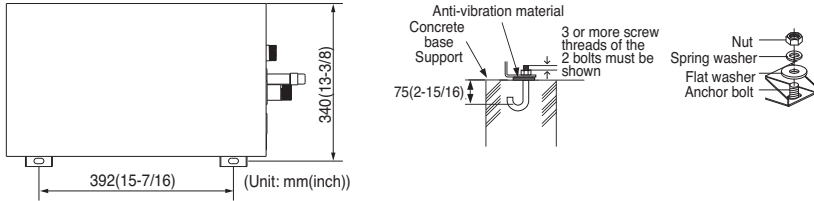

Drain pipe connection

- **Hydro Kit** does not use the drain pump.
- Do not install in upward direction.
- Install the drain pipe in downward direction (1/50-1/100).
- **Hydro Kit** drain connection pipe is PT 1.

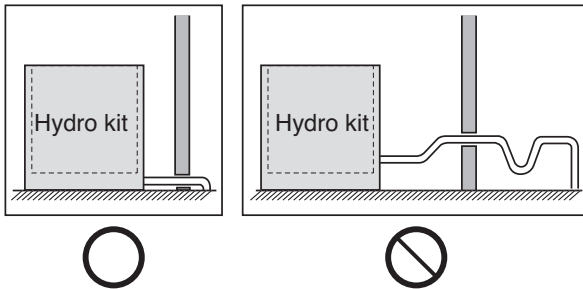

Water Piping and Water Circuit Connection

General Considerations

Followings should be considered before beginning water circuit connection.

- Service space should be secured.
- Water pipes and connections should be cleaned using water.
- Space for installing external water pump should be provided.
- Never connect electric power while proceeding water charging.

Water Piping and Water Circuit Connection

While installing water pipes, followings should be considered :

- While inserting or putting water pipes, close the end of the pipe with pipe cap to avoid dust entering.
- When cutting or welding the pipe, always be careful that inner section of the pipe should not be defective. For example, no weldments or no burrs are found inside the pipe.
- Pipe fittings (e.g. L-shape elbow, T-shape tee, diameter reducer, etc) should be tightened strongly to be free from water leakage.
- Connected sections should be leakage-proof treatment by applying tefron tape, rubber bushing, sealant solution, etc.
- Appropriate tools and tooling methods should be applied to prevent mechanical breakage of the connections.
- Operation time of flow valve(e.g. 3way valve or 2way valve) should be less than 90 seconds.
- Pipe is insulated to prevent heat loss to external environment.

Water cycle

* For the water pipe system, use the closed loop type.

- For the parts of the water pipe system, use the parts above the design water pressure.
- For the water pipe, do not use steel pipe.
- For the drain pipe (1) size, use the same diameter as the product connected or larger.
 - Always install a natural drainage so that the drained water does not back flows.
- To replace the connected device easily, install the union joint (2).
- Install the service port (3) to clean the heat exchanger at each inlet and outlet of the water pipe.
- Always install a strainer(4) at the inlet of the water pipe. Do not enter city water into the water pipe directly during Hydro Kit operation. If the strainer is not installed, component malfunction of Hydro Kit may occur.
 - For the strainer, use one with 50 mesh or above with measurement diameter of 0.4mm or less. (Exclude other net)
 - Always install the strainer on the horizontal pipe. (When dirt, trash, rusted pieces get into the water pipe system, it can cause problems to the product by corroding the metallic material.)
- Install the air vent(5) at the top of the water pipe. If the air vent is not installed at the top of the water pipe, there would be a lot of bubble in the water pipe. So a plate heat exchanger burst may happen because of the reduction of water flow rate(CH 14 is displayed in the remote controller) caused by a lot of bubble in the water pipe.
- Install a thermometer (6) and pressure gauge (7) at the inlet and outlet of the water pipe.
- Install the drain valve (8) that can be used for draining the water inside when replacing the part or providing service.
- Install the shut-off valve (9) to block the water by closing the valve when replacing the part or cleaning.
- Apply insulated treatment on the exterior of the water pipe so that water drops do not form.
- Install excessive pressure safety valve (10) that meets the design water pressure to prevent unit or water pipe damage at the pressure increase inside the water pipe system.
- Install the closed loop water pipe system.

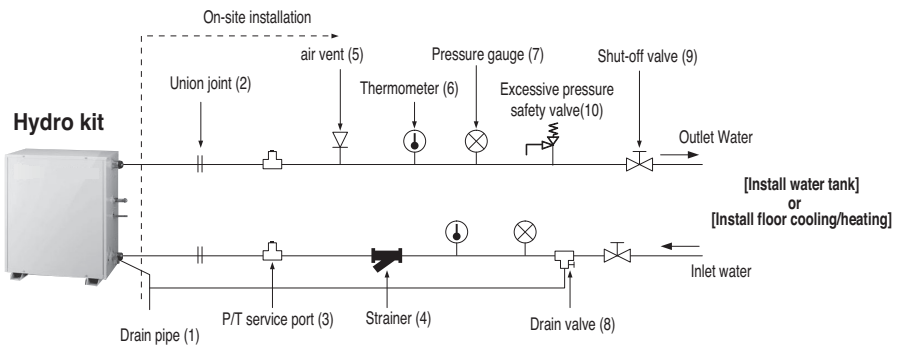

CAUTION:

Please always make circulate or drain out the water completely when not using it.

* WATER TANK & FLOOR HEATING INSTALLATION

1. Use the pump (1) with sufficient capacity to assure loss of overall water pressure and to supply water to the **Hydro Kit**.
2. Install the shut-off valve (2) on both sides of the pump to clean and repair the pump.
3. Install the flexible joint (3) to prevent noise and vibration transferred from the pump.
4. Install the pressure gauge (4) to monitor the water pressure from water tank. (Option)
5. Install the expansion tank (5) to accommodate the water contracted or expanded from the temperature difference and to supply the water.
6. After the installation of water pipe system is completed, open the water supply valve (6) and supply the water.
7. When installing the water tank, insert the water tank temperature sensor (7) to measure the temperature of the water inside the tank.
 - For the water tank temperature sensor, use the sensor supplied on the product.
 - When heating the floor, measure the temperature by using the remote controller or remote temperature sensor (Separately sold).
8. Use the water tank (9) with the heat exchange coil (8) installed so that the heat can be exchanged sufficiently inside the tank.

Installation of water tank

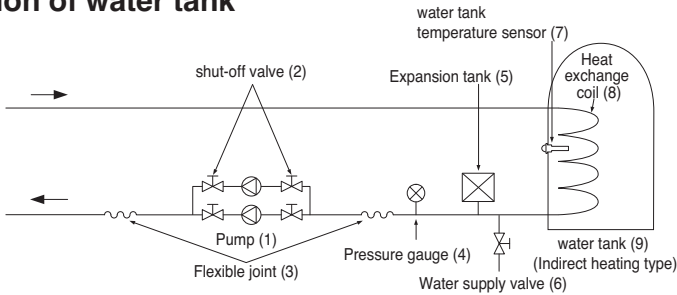

Installation of floor heating

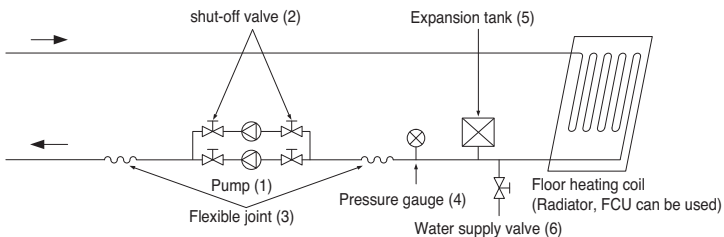

Strainer

- Use the 50 mesh strainer.
(Exclude scale diameter of 0.4mm or less and other net)
- Check the strainer direction and assemble on the inlet hole (Refer to picture)
- Wrap the Teflon tape on the screw thread of the water pipe for more than 15 times for assembly.
- Install the service port facing downward. (Within left/right 45 degrees)
- Check if there is any leakage on the connecting part.
- Clean the strainer periodically. (Once a year or more frequent)

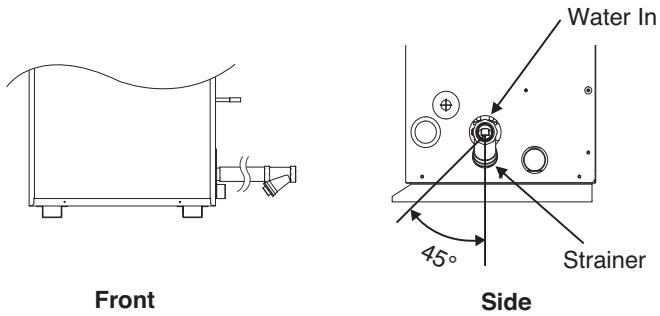

Sanitary Water Tank and Sanitary Water Tank Kit

Installation Condition

Installing sanitary water (DHW) tank requires following considerations :

- Sanitary water tank should be located at the flat place.
- Water quality should comply with EN 98/83 EC Directives.
- As this water tank is sanitary water tank (indirect heat exchange), do not use anti water-freezing treatment like ethylene glycol.
- It is highly recommend to wash out inside of the sanitary water tank after installation. It ensures generating clean hot water.
- Near the sanitary water (DHW) tank , there should be water supply and water drain for easy access and maintenance.

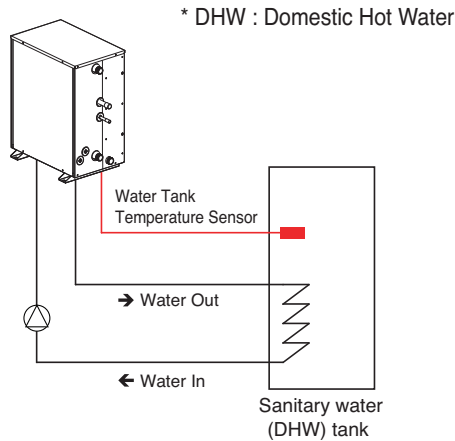

Water tank temperature sensor connection

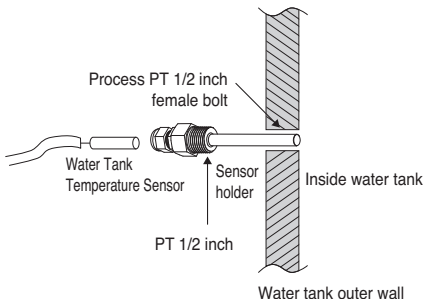

- If hot water mode is used, make sure to install sensor to water tank.
- Make PT15A female bolt hole in the water tank, and install sensor in the water tank.
- Push the sensor into the hole of the sensor holder cap.
- Lock the sensor holder cap.

**WARNING :****Installing recirculation pump**

When Hydro Kit is used with the sanitary water tank, it is **STRONGLY** recommended to install recirculation pump to prevent cold water at the end of hot water supply flooding out and to stabilize the water temperature inside the sanitary water tank.

- The recirculation pump should be operated when sanitary water demand is not required. Therefore, external time scheduler to determine when the recirculation pump should turn on and turn off is required.

- The operating duration time of the recirculation pump is calculated as follow :

$$\text{Duration time [minute]} = k * V / R$$

k : 1.2 ~ 1.5 is recommended.

(If distance between pump and tank is far, then choose high number.)

V : Volume of sanitary water tank [liter]

R : Water flow rate of pump [liter per minute], which is determined by pump performance curve.

- The pump operating start time should be prior to the sanitary water demand.

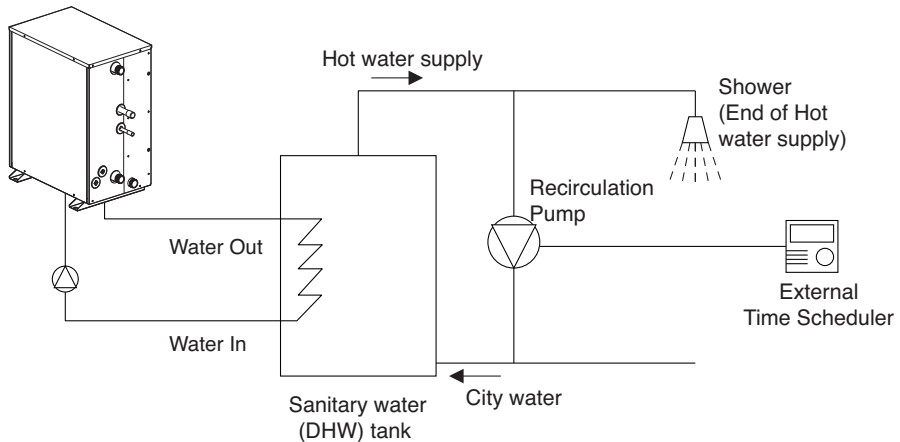

Solar Thermal Kit

How to Install Solar Thermal Kit

- Step 1.** Check the diameter of pre-installed pipes. (symbol Ⓐ and Ⓑ)
- Step 2.** If the diameter of pre-installed pipes is different from diameter of solar thermal kit, it is necessary to reduce or extend of pipe's diameter.
- Step 3.** After Step 2., connect the pipe and solar thermal kit.
- Step 4.** Connect solar thermal sensor to 'CN_TH4'(Red connector) of the indoor unit PCB.
If the water tank sensor is connected, disconnect the sensor from PCB first.

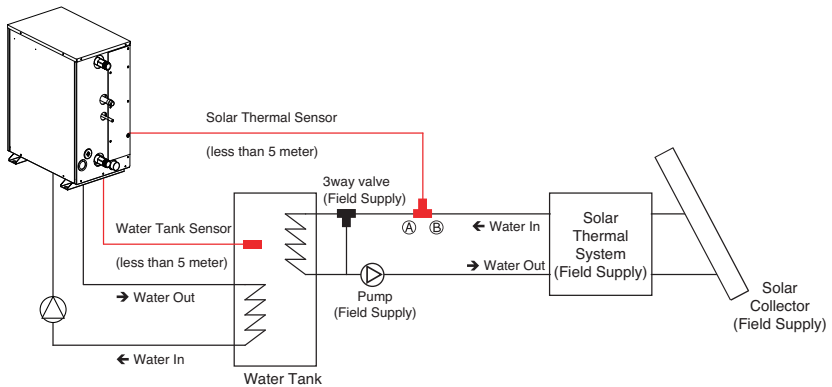

Installation Scenes

Some installation scenes are presented for example. As these scenes are conceptual figures, installer should optimize the installation scene according to the installation conditions. This is a simple concept diagram. Refer to the water cycle (page 12,13) for installation components.

1) Floor Heating only (Without mixing tank)

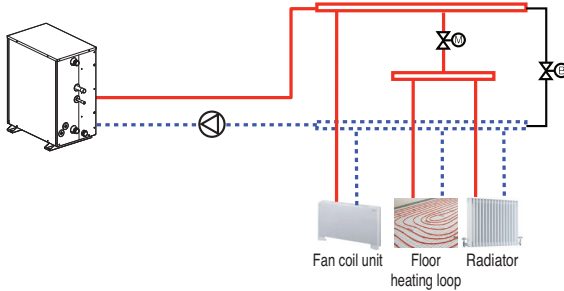

2) Floor Heating only (With mixing tank)

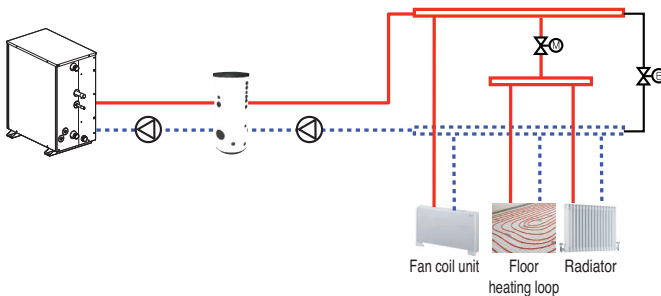

WARNING

At the installation site where Hydro Kit is combined with a mixing tank, each water-circulation pump (one is installed between Hydro Kit and the mixing tank, the other is installed between the mixing tank and indoor units (FCU, Radiator and so on)) should be always operated simultaneously to protect mixing tank from risk of freezing and bursting. All of pumps should be linked with Hydro Kit.

3) Floor Heating + Hot water

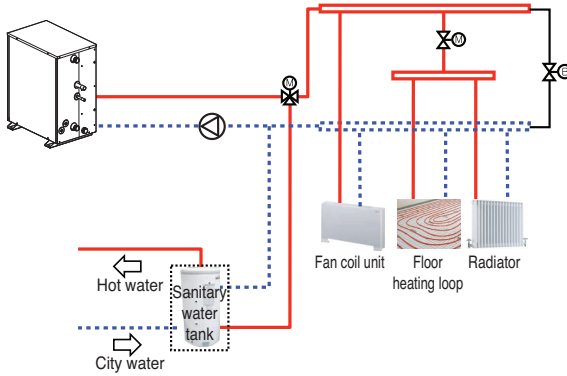

4) Floor Heating + Hot Water + Solar Thermal

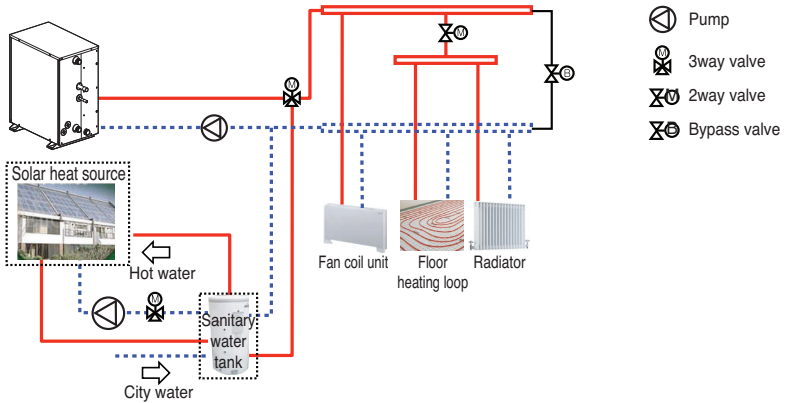

Water Quality

Water quality should comply with EN 98/83 EC Directives. Requirement for resolved chemical ingredients is following table. Detailed water quality condition can be found in EN 98/83 EC Directives.

Parameter	Value	Parameter	Value
Acrylamide	0.10 µg/l	Fluoride	1.5 mg/l
Antimony	5.0 µg/l	Lead	10 µg/l
Arsenic	10 µg/l	Mercury	1.0 µg/l
Benzene	1.0 µg/l	Nickel	20 µg/l
Benzo(a)pyrene	0.010 µg/l	Nitrate	50 mg/l
Boron	1.0 mg/l	Nitrite	0.50 mg/l
Bromate	10 µg/l	Pesticides	0.10 µg/l
Cadmium	5.0 µg/l	Pesticides — Total	0.50 µg/l
Chromium	50 µg/l	Polycyclic aromatic hydrocarbons	0.10 µg/l
Copper	2.0 mg/l	Selenium	10 µg/l
Cyanide	50 µg/l	Tetrachloroethene and Trichloroethene	10 µg/l
1,2-dichloroethane	3.0 µg/l	Trihalomethanes — Total	100 µg/l
Epichlorohydrin	0.10 µg/l	Vinyl chloride	0.50 µg/l

**CAUTION:**

- If the unit is installed at existing hydraulic water loop, it is important to clean hydraulic pipes to remove sludge and scale.
- Installing sludge strainer in the water loop is very important to prevent performance degrade.
- Chemical treatment to prevent rust should be performed by installer.

Freezing protection

In areas of the country where entering water temperatures drop below 15°C(59°F), the water pipe must be protected by using an approved antifreeze solution. Consult your **Hydro Kit** unit supplier for locally approved solutions in your area. Calculate the approximate volume of water in the system. (Except the **Hydro Kit** unit.) And add antifreeze solution to the total volume to allow for the water contained in **Hydro Kit** unit.

Type of Antifreeze	Minimum Temperature for Freeze Protection				
	15°C(59°F) ~ -5°C(23°F)	-10°C(14°F)	-15°C(5°F)	-20°C(-4°F)	-25°C(-13°F)
Ethylene glycol	12%	20%	30%	-	-
Propylene glycol	17%	25%	33%	-	-
Methanol	6%	12%	16%	24%	30%

**CAUTION:**

1. Use only one of the above antifreeze.
2. If a antifreeze is used, pressure drop and capability degradation of the system can occur.
3. If one of antifreezes is used, corrosion can occur. So please add corrosion inhibitor.
4. Please check the concentration of the antifreeze periodically to keep same concentration.
5. When the antifreeze is used (for installation or operation), take care to ensure that antifreeze must not be touched.
6. Ensure to respect all laws and norms of your country about Anti-freeze usage.
7. When hydro kit is applied for cooling, the antifreeze must be added in the water circuit to prevent freezing.
8. Set the DIP S/W and short key to Anti Freeze mode only after the addition of brine(Anti-freeze). Or else the product may get damage due to freezing and bursting.

**WARNING:**

Do not add brine(Anti-freeze) to the water circuit when it is used for hot water.

Refrigerant Piping

Cut the pipes and the cable

- Use the accessory piping kit or the pipes purchased locally.
- Measure the distance between the indoor and the outdoor unit.
- Cut the pipes a little longer than measured distance.
- Cut the cable 1.5m longer than the pipe length.

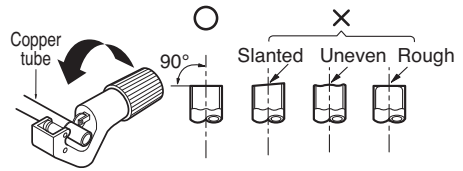

Burrs removal

- Completely remove all burrs from the cut cross section of pipe/tube.
- Put the end of the copper tube/pipe to downward direction as you remove burrs in order to avoid to let burrs drop in the tubing.

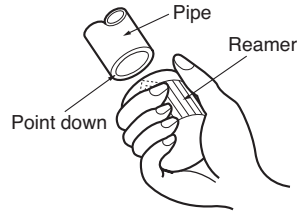

Pipe welding

- Insert and weld the pipe.
- Always make sure to flow Nitrogen at 0.2kgf/cm² within the pipe when welding.
- If the welding is done without flowing Nitrogen, it can generate a thick oxidized coating within the pipe to interfere with normal operation of valve and compressor etc.

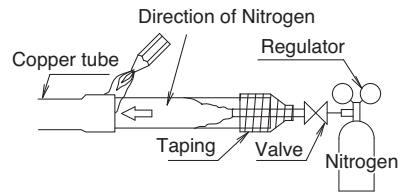

Insulation

- Use rubber foamed insulation material (EPDM, NBR) with high thermal resistance.
- When installed in humid environment, use thicker insulation material than usual.
- Insert the insulation material within the product as deep as possible.

Classification	Thickness
Liquid pipe(Ø9.52)	t9 or above
Gas pipe(Ø22.2 - 10HP Ø15.88 - 4HP)	t19 or above

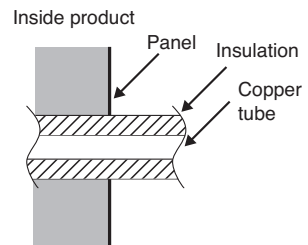

※ The thickness of the above insulation material is based on thermal conduction rate of 0.036W/m °C.

When installing independent power module, refrigerant piping should be installed in accordance with the manual of independent power module

Precaution when connecting Heat Recovery systems

PRHR042 / PRHR032 / PRHR022

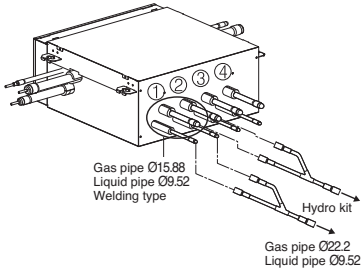

- One connection of refrigerant pipe for HR unit is insufficient for the flow of refrigerant. Join two pipes with a branch pipe when connecting the **Hydro Kit** (Up to 16kW (54kBut/h) capacity model: 10HP).
- The pipe number of the connected gas pipe and liquid pipe must be same.
- Flow water in the **Hydro Kit** when pipe-searching process is performed.
- Pipe-searching process error may occur if the pipe temperature does not increase.
- It is recommended that **Hydro Kit** (10HP model) is connected to No.1 valve and No.2 valve.

	DIP S/W setting	Example
Not control		
No.1, 2 Valve Control		
No.2, 3 Valve Control		
No.3, 4 Valve Control		
No.1, 2 Valve / No.3, 4 Valve Control		

Pipe searching process

- When Pipe searching process is performed,
 - Use 'Mode 1' if water temperature is higher than 30°C(86°F)
 - Use 'Mode 2' if water temperature is lower than 30°C(86°F)
- When Pipe searching process is not performed,
 - Check whether 'CH14' error occurs in the **Hydro Kit**.



For more detailed information, refer to the installation manual of Heat Recovery Unit.

Precaution when connecting Heat Recovery systems

PRHR083 / PRHR063 / PRHR043 / PRHR033 / PRHR023

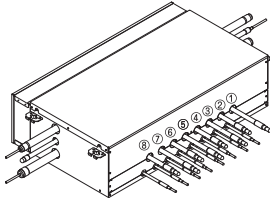

- One connection of refrigerant pipe for HR unit is insufficient for the flow of refrigerant. Join two pipes with a branch pipe when connecting the **Hydro Kit** (Up to 61kBTU capacity model: 10HP).
- The pipe number of the connected gas pipe and liquid pipe must be same.
- Flow water in the **Hydro Kit** when pipe-searching process is performed.
- Pipe-searching process error may occur if the pipe temperature does not increase.
- It is recommended that **Hydro Kit** (10HP model) is connected to No.1 valve and No.2 valve.

Valve Group	SW01D Setting	Valve Group	SW01D Setting
Not control	0	No. 5,6/7,8 Valve Control	8
No. 1,2 Valve Control	1	No. 1,2/5,6 Valve Control	9
No. 2,3 Valve Control	2	No. 1,2/7,8 Valve Control	A
No. 3,4 Valve Control	3	No. 3,4/5,6 Valve Control	B
No. 5,6 Valve Control	4	No. 3,4/7,8 Valve Control	C
No. 6,7 Valve Control	5	No. 1,2/3,4/5,6 Valve Control	D
No. 7,8 Valve Control	6	No. 1,2/3,4/6,7 Valve Control	E
No. 1,2/3,4 Valve Control	7	No. 1,2/3,4/7,8 Valve Control	F

Pipe searching process

1. When Pipe searching process is performed,
 - Use 'Mode 1' if water temperature is higher than 30°C(86°F)
 - Use 'Mode 2' if water temperature is lower than 30°C(86°F)
2. When Pipe searching process is not performed,
 - Check whether 'CH14' error occurs in the **Hydro Kit**.



For more detailed information, refer to the installation manual of Heat Recovery Unit.

How to connect wirings

Remove the box cover of electric parts and connect the wiring.

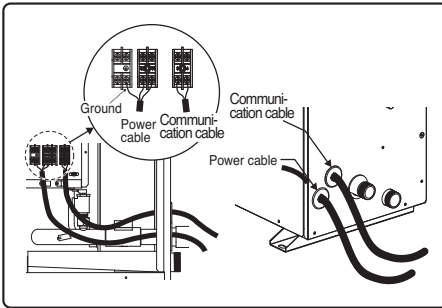

CAUTION:

When connecting the power and communication cable, always use the terminal connector (O-ring, Y-ring).

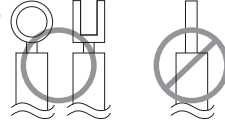

Make sure to tighten so that the screw of the terminal does not get loose.

Wiring Connection

Connect the wires to the terminals on the control board individually according to the outdoor unit connection.

- Ensure that the wire color of the outdoor unit and terminal No. are same as those of the indoor unit respectively.

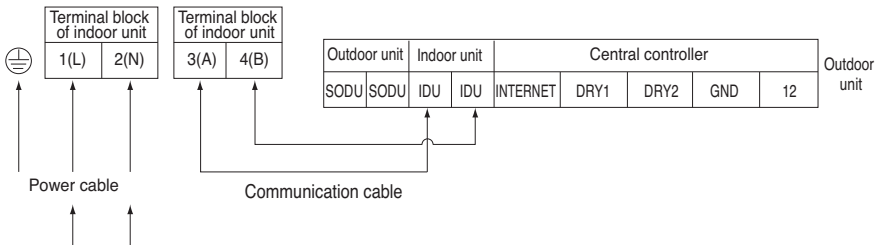

※ Resistance measurement position for incorrect wiring.



WARNING : Make sure that the screws of the terminal are free from looseness.



CAUTION:

Be sure to test the power line and communication line for incorrect wiring before power is applied.

- 1) If the power line and communication line are swapped over, the product will be damaged.
- 2) Incorrect wiring confirmation test method

: Measure the resistance across the power terminals (L,N) using a multi meter.

- Resistance value of a normal connection: 1 MΩ or more
- Incorrect wiring resistance value: 500 mΩ or less



CAUTION:

After the confirmation of the above conditions, prepare the wiring as follows:

- 1) Never fail to have separate power specially for the air conditioner. As for the method of wiring, follow the circuit diagram pasted on the inside of control box cover.
- 2) Provide a circuit breaker switch between power source and the unit.
- 3) The screw which fasten the wiring in the casing of electrical fittings are liable to come loose from vibrations to which the unit is subjected during the course of transportation. Check them and make sure that they are all tightly fastened. (If they are loose, it could give rise to burn-out of the wires.)
- 4) Confirm the Specification of power source
- 5) Confirm that electrical capacity is sufficient.
- 6) Be sure that the starting voltage is maintained at more than 90 percent of the rated voltage marked on the name plate.
- 7) Confirm that the cable thickness is as specified in the power sources specification.
(Particularly note the relation between cable length and thickness.)
- 8) Do not install the leakage breaker in a place which is wet or moist.
Water or moist may cause short circuit.
- 9) The following troubles would be caused by voltage drop-down.
 - Vibration of a magnetic switch, damage on the contact point there of, fuse breaking, disturbance to the normal function of a overload protection device.
 - Proper starting power is not given to the compressor.
- 10) Before applying power to the indoor unit, be sure to check for incorrect wiring of the power and communication lines.
- 11) If the supply cord is damaged, it must be replaced by the manufacturer, its service agent or similarly qualified persons in order to avoid a hazard.

Connecting Cables

The distance between communication cable and power cable

- If the power cable and communication cable are tied together, system malfunction may occur with electrostatic, electromagnetic combination effect causing the interference signal. If communication cable is connected along with power cable, secure at least 50 mm distance between indoor unit power cable and communication cable.

It is the value with the assumption of the length of the parallel cable as 100 m. If it is longer than 100 m, it shall be calculated again with proportional to the added length.

If the distortion in the waveform of the power still occurs despite securing the distance, increase the distance.

※ When several power cables are inserted into the transmission line, or tied together, make sure to consider the following issues.

- Power cables and communication cable shall not be in the same transmission line.
- Power cables and communication cable shall not be tied together.



WARNING

- Are all of the indoor units and outdoor units grounded?
- If grounding is not properly done, there is a risk of electric shock. Grounding must be done by a qualified technician.
- Consider the surrounding conditions (surrounding temperature, direct sunlight, rain water, etc.) when wiring the cable.
- The thickness of the power cable is the minimum thickness of metal conductor cable. Use thicker cable considering the voltage drop.

5. Accessories Installation

Location of Accessories and External Parts Connection

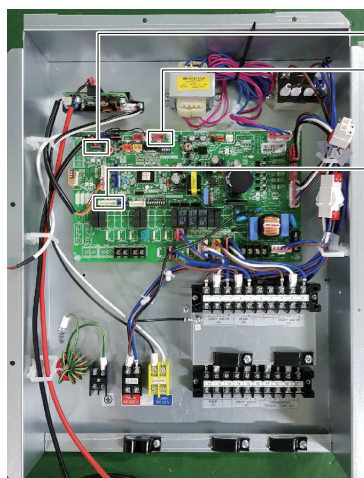

- Remote controller locking location (CN-REMO)
- Water tank temperature sensor locking location (CN-TH4)
- Dry contact board locking location (CN-CC)

3WAY VALVE (B)			WATER PUMP (B)				3WAY VALVE (A)		
1 L	2 L1	3 N	4 L	5 N	6	7	8 L	9 L1	10 N
BR	WH	BL	BR	BL			BR	WH	BL

PUMP (A)			2WAY VALVE (A)			THERMOSTAT (Default : 230 V AC)			
11 L	12 N	13	14 L1	15 L2	16 N	17 L	18 N	19 L1	20 L2
BR	BL		BR	WH	BL	BR	BL	WH	BK

- Connect 3way valve, if both floor heating and hot water is used.
- Connect the separately purchased thermostat.
- Dry contact is an accessory supplied by LG and installed by referring to the attached installation manual.
- 3way valve, thermostat and pump are external parts for installation, which are not supplied by LG. After checking each part carefully, install external parts respectively.
- Connect the cable of each accessory to the terminal block of the control box in the **Hydro Kit**.
- Check the label attached on the terminal block to prevent wrong connection.
- Use the pump of 220 voltage and maximum operation current of 4A or less.
- Select a suitable relay for pump capacity when connecting the pump to the unit.



WARNING:

- Install the unit after turning off the main power.
- Do not connect the products out of range specified in the manual.
- Do not work with wet hand.

Installation of Wired Remote Controller

1. Please fix tightly using provided screw after placing remote controller setup board on the place where you like to setup.

- Please set it up not to bend because poor setup could take place if setup board bends.
- Please set up remote controller board fit to the reclamation box if there is a reclamation box.

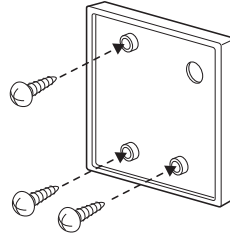

2. Can set up Wired remote controller cable into three directions.

- Setup direction: the surface of wall reclamation, upper, right
- If setting up remote controller cable into upper and right side, please set up after removing remote controller cable guide groove.

※ Remove guide groove with long nose.

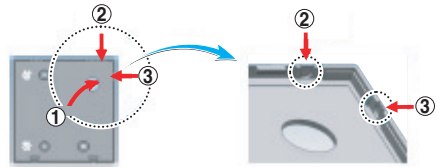

<Wire guide grooves>

- ① Reclamation to the surface of the wall
- ② Upper part guide groove
- ③ Right part guide groove

3. Please fix remote controller upper part into the setup board attached to the surface of the wall, as the picture below, and then, connect with setup board by pressing lower part.

- Please connect not to make a gap at the remote controller and setup board's upper and lower, right and left part.

<Connecting order>

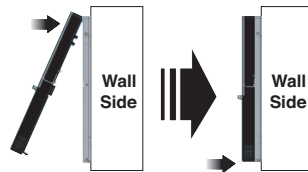

<Separating order>

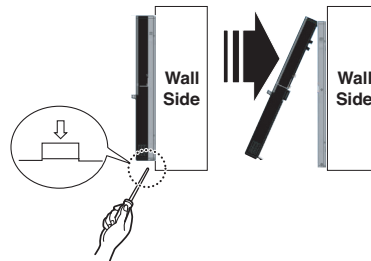

When separating remote controller from setup board, as the picture below, after inserting into the lower separating hole using screw driver and then, spinning clockwise, remote controller is separated.

- There are two separating holes. Please individually separate one at a time.
- Please be careful not to damage the inside components when separating.

4. Please connect indoor unit and remote controller using connection cable.

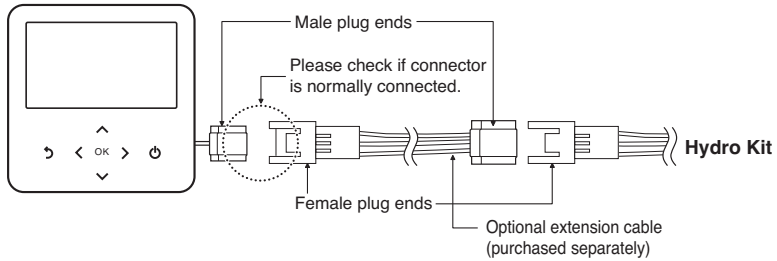

5. Please use extension cable if the distance between wired remote controller and indoor unit is more than 10 m.

Extension cable(10 m) model name : PZCWRC1

⚠ CAUTION

When installing the wired remote controller, do not bury it in the wall.

(It can cause damage in the temperature sensor.)

Do not install the cable to be 50 m or above. (It can cause communication error.)

- When installing the extension cable, check the connecting direction of the connector of the remote controller side and the product side for correct installation.
- If you install the extension cable in the opposite direction, the connector will not be connected.
- Specification of extension cable: 2547 1007 22# 2 core 3 shield 5 or above.

Main Pump Connection

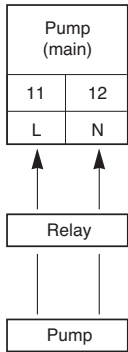

- Select the suitable pump by referring to the flow rate table with water temperature difference between the entrance and the exit.
- It is recommended that the flow rate is Rated water flow (refer to the specification of PDB)
- Use the pump with enough capacity to guarantee the loss of entire water pressure and to supply the **Hydro Kit** with water.
- Select a suitable relay for pump capacity when connecting the pump to the unit.
- Connect the relay to the terminal block 11 and 12 of the control box.



CAUTION:

- Make sure to supply external power with the pump.

Water tank temperature sensor Connection

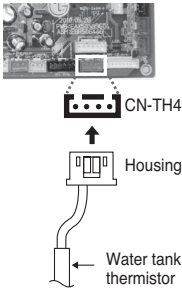

- Connect sensor housing to PCB'CN-TH4' connector (red).



CAUTION:

- If water tank temperature sensor is not connected, error will occur.
(CH08) Exclude the case of using floor heating.

Thermostat

Thermostat is generally used to control the unit by air temperature. When thermostat is connected to the unit, the unit operation is controlled by the thermostat.

Installation Condition



CAUTION:

1. USE 1~230 V Thermostat.
2. Some electro-mechanical type thermostat has internal delay time to protect compressor. In that case, mode change can take time more than user's expectation. Please read thermostat manual carefully if the unit does not response quickly.
3. Setting temperature range by thermostat can be different with that of the unit. The heating set temperature should be chosen within the setting temperature range of the unit.
4. It is highly recommended that the thermostat should be installed where space heating is mainly applied.

Following location should be avoid to secure proper operation :

- Height from floor is approximately 1.5 m.
- Thermostat can not be located where the area may be hidden when door is open.
- Thermostat can not be located where external thermal influence may be applied. (such as above heating radiator or open window)

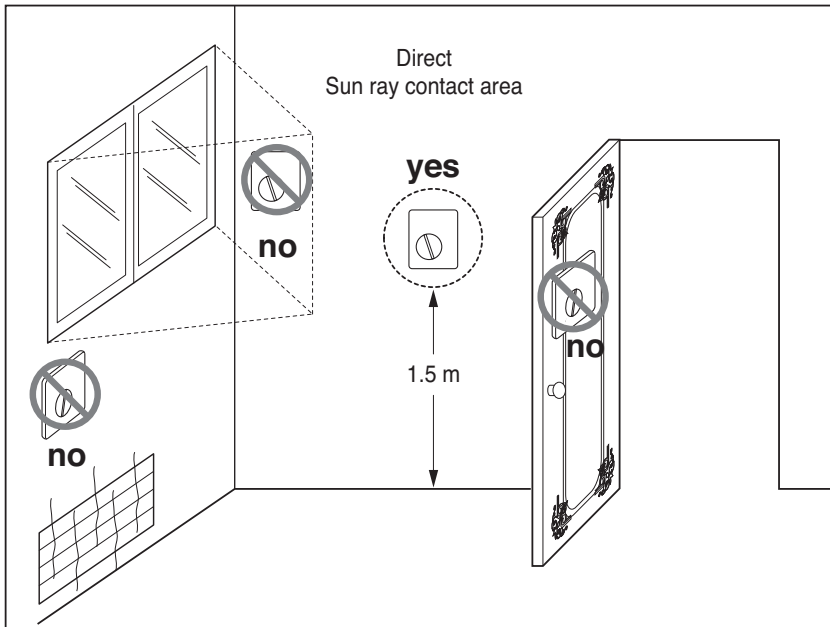

General Information

Hydro Kit supports following thermostats.

Type	Power	Operating Mode	Supported
Mechanical (1)	1~ 230 V	Heating Only (3)	Yes
		Heating / Cooling (4)	Yes
	1~ 24 V	Heating Only (3)	Yes
		Heating / Cooling (4)	Yes
Electrical (2)	1~ 230 V	Heating Only (3)	Yes
		Heating / Cooling (4)	Yes
	1~ 24 V	Heating Only (3)	Yes
		Heating / Cooling (4)	Yes

- (1) There is no electric circuit inside the thermostat and electric power supply to the thermostat is not required.
- (2) Electric circuit such as display, LED, buzzer, etc is included in the thermostat and electric power supply is required.
- (3) Thermostat generates "Heating ON or Heating OFF" signal according to user's heating target temperature.
- (4) Thermostat generates both "Heating ON or Heating OFF" and "Cooling ON or Cooling OFF" signal according to user's heating and cooling target temperature.



CAUTION:

Choosing Heating / Cooling Thermostat

- Heating / Cooling Thermostat must have "Mode Selection" feature to distinguish operation mode.
- Heating / Cooling Thermostat must be able to assign heating target temperature and cooling target temperature differently.
- If above conditions are not kept, the unit can not operation properly.
- Heating / Cooling Thermostat must send cooling or heating signal immediately when temperature condition is satisfied. No delay time while sending cooling or heating signal is permitted.

How to Wire Thermostat

Follow below procedures Step 1 ~ Step 6.

Step 1. Uncover front cover of the unit and open the control box.

Step 2. Identify the power specification of the thermostat. If it is 1~ 230 V, go to Step 4. Otherwise, if it is 1~ 24 V, go to step 3.

Step 3. Find thermostat connecting cable A and C. Disconnect cable A and C, then connect cable B and C.

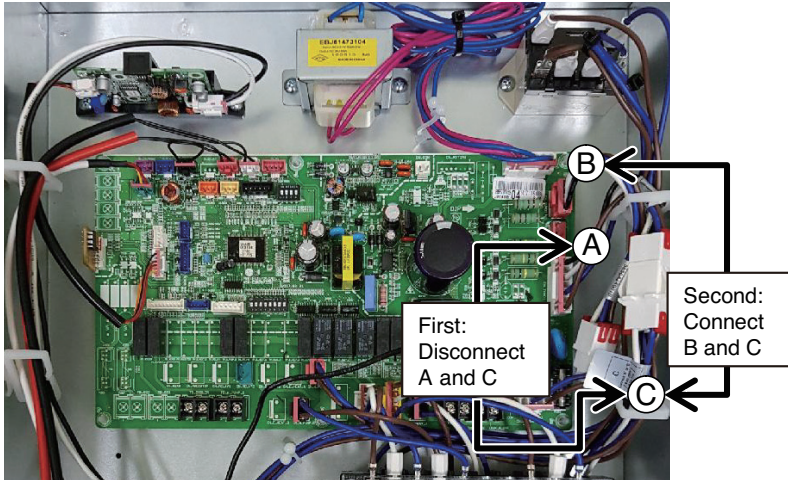

Step 4. If it is Heating Only Thermostat, go to step 5. Otherwise, if it is Heating / Cooling Thermostat, go to step 6.

Step 5. Find terminal block and connect wire as below. After connecting, go to step 6.

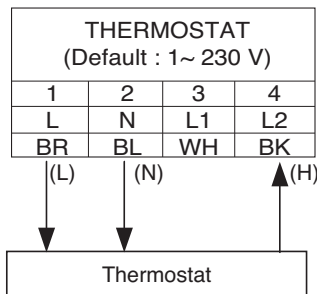

! WARNING :

Mechanical type Thermostat.

Do not connect wire (N) as mechanical type thermostat does not require electric power supply.

! CAUTION:

Do not connect external electric loads.

Wire (L) and (N) should be used only for operation Electric type thermostat.

Never connect external electric loads such as valves, fan coil units, etc. If connected, Main PCB Assembly 1 can be seriously damaged.

(L) : Live signal from PCB to Thermostat

(N) : Neutral signal from PCB to Thermostat

(H) : Heating signal from Thermostat to PCB

Step 6. Find terminal block and connect wire as below.

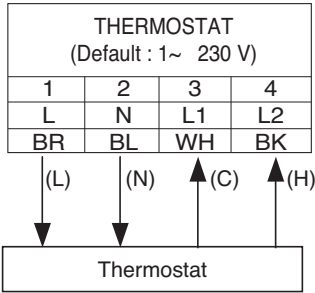

WARNING :

Mechanical type Thermostat.

Do not connect wire (N) as mechanical type thermostat does not require electric power supply.



CAUTION:

Do not connect external electric loads.

Wire (L) and (N) should be used only for operation Electric type thermostat.

Never connect external electric loads such as valves, fan coil units, etc. If connected, Main PCB Assembly 1 can be seriously damaged.

(L) : Live signal from PCB to Thermostat

(N) : Neutral signal from PCB to Thermostat

(C) : Cooling signal from Thermostat to PCB

(H) : Heating signal from Thermostat to PCB

Final Check

- DIP switch setting :
Set DIP switch No. 8 to 'ON' (Check the system set-up of Chapter 7). Otherwise, the unit can not recognize the thermostat.
- Remote Controller :
 - 'Thermostat' text is displayed on the remote controller.
 - Button input is prohibited.

Remote Temperature Sensor

Remote temperature sensor can be installed any place a user wants to detect the temperature.

How to Install Remote Temperature Sensor

Step 1. After deciding where the remote temperature sensor is installed, decide the location and height of the fixing screws. (Interval between the screws : 60 mm)

Step 2. Insert the connector of the connection wire into the space for the connector in place of the room temperature sensor.(CN_ROOM)

Step 3. Separately, set the option code of the attached controller on the indoor unit.
In detail, refer to "installer setting mode".

Step 4. The Connection wire does not matter if you change the color of the wire because of non-polar.

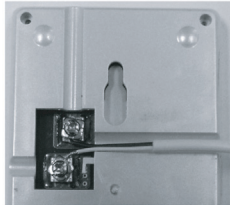
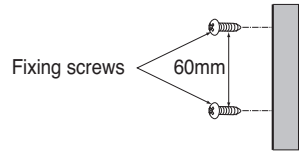

Step 5. Integrate the remote temperature sensor with the screws as the order of arrows.

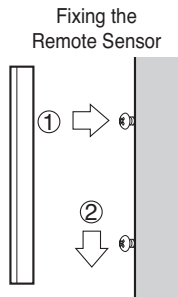

CAUTION:

1. Choose the place where the average temperature can be measured for the indoor unit operates.
2. Avoid direct sunlight.
3. Choose the place where the heating devices do not affect the remote sensor.
4. Choose the place where the outlet of the cooling fan do not affect the remote sensor.
5. Choose the place where the remote sensor isn't affected when door is open.

3Way Valve

3way valve is required to operate sanitary water tank. Role of 3way valve is flow switching between under floor heating loop and water tank heating loop.

General Information

Hydro Kit supports following 3way valve.

Type	Power	Operating Mode	Supported
SPDT 3-wire (1)	1~ 230 V	Selecting "Flow A" between "Flow A" and "Flow B" (2)	Yes
		Selecting "Flow B" between "Flow A" and "Flow B" (3)	Yes

(1) SPDT = Single Pole Double Throw. Three wires consist of Live (for selecting Flow A), Live 1 (for selecting Flow B), and Neutral (for common).

(2) Flow A means 'water flow from the unit to sanitary water tank'

(3) Flow B means 'water flow from the unit to under floor water circuit'

How to Wire 3Way Valve

Follow below procedures Step 1 ~ Step 2.

Step 1. Uncover front cover of the unit and open the control box.

Step 2. Find terminal block and connect wire as below.

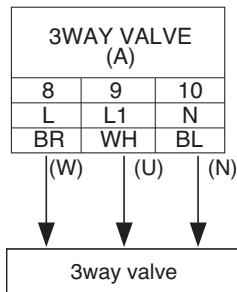

WARNING :

- 3way valve should select water tank loop when electric power is supplied to wire (W) and wire (N).
- 3way valve should select under floor loop when electric power is supplied to wire (U) and wire (N).

(W) : Live signal (Water tank heating) from PCB to 3way valve

(U) : Live signal (Under floor heating) from PCB to 3way valve

(N) : Neutral signal from PCB to 3way valve

WARNING :

Mice can not be appeared to prevent entering the unit or attacking wires.

Final Check

- Flow direction :
 - Water should flow from water outlet of the unit to sanitary tank water inlet when sanitary tank heating is selected.
 - To verify the flow direction, check temperature at the water outlet of the unit and water inlet of sanitary water tank.
 - If correctly wired, these temperatures should be almost equivalent if thermal insulation of water pipe is well performed.

- Noise or water pipe vibration while 3way valve operation
 - Due to surging effect or cavitation effect, noise or water pipe vibration can be occurred while 3way valve is operating.
 - In that case, check followings :
 - Is water circuit (both under floor water loop and sanitary water tank loop) fully charged? If not, additional water charging is required.
 - Fast valve operation yields noise and vibration. Appropriated valve operating time is 60~90 seconds.

2Way Valve

2way valve is required to control water flow while cooling operation. Role of 2way valve is to cut off water flow into under floor loop in cooling mode when fan coil unit is equipped for cooling operation.

General Information

Hydro Kit supports following 2way valve.

Type	Power	Operating Mode	Supported
NO 2-wire(1)	230 V AC	Closing water flow	Yes
		Opening water flow	Yes
NC 2-wire(2)	230 V AC	Closing water flow	Yes
		Opening water flow	Yes

(1) : Normal Open type. When electric power is NOT supplied, the valve is open.
(When electric power is supplied, the valve is closed.)

(2) : Normal Closed type. When electric power is NOT supplied, the valve is closed.
(When electric power is supplied, the valve is open.)

How to Wire 2Way Valve

Follow below procedures Step 1 ~ Step 2.

Step 1. Uncover front cover of the indoor unit and open the control box.

Step 2. Find terminal block and connect wire as below.

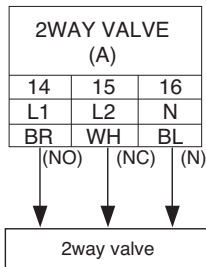

CAUTION :

Dew Condensation

- Wrong wiring can yield dew condensation on the floor. If radiator is connected at the under floor water loop, dew condensation can be occurred on the surface of the radiator.

WARNING :

Wiring

- Normal Open type should be connected to wire (NO) and wire (N) for valve closing in cooling mode.

(NO) : Live signal (for Normal Open type) from PCB to 2way valve

(NC) : Live signal (for Normal Closed type) from PCB to 2way valve

(N) : Neutral signal from PCB to 2way valve

Final Check

- Flow direction :
 - Water should not flow into under floor loop in cooling mode.
 - To verify the flow direction, check temperature at the water inlet of the under floor loop.
 - If correctly wired, this temperatures should not be approached to 6°C(42°F) in cooling mode.

Independent Power Module

Independent power module is required to protect a plate heat exchanger burst. When the outdoor unit is operating, if Hydro Kit is suddenly powered off, a plate heat exchanger burst may happen during oil-return and defrosting cycle in cooling mode.

How to install Independent Power Module

Step 1. Open the front panel of the control box

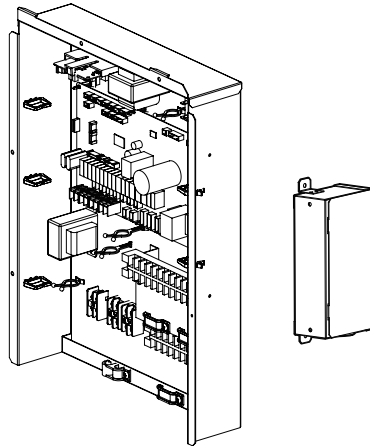

Step 2. Assemble the cover of independent power module, fix it tightly with bolts and connect wires.

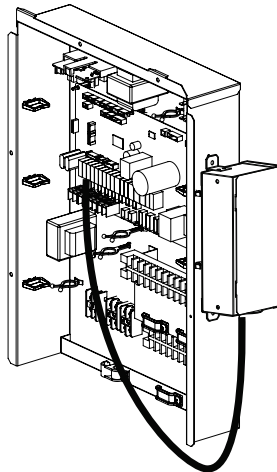

How to wire Independent Power Module

- Step 1. Turn the power off using circuit breaker.
- Step 2. Disconnect the EEV cable of the indoor units PCB(CN-EEV)
- Step 3. Connect the independent power kit(CN-EEV/LOAD) to the indoor units EEV, using harness 1.
- Step 4. Connect the independent power kit(CN-EEV/MAIN) to the indoor units PCB(CN-EEV/CN-WRITE), using harness 2.
- Step 5. Supply the power.

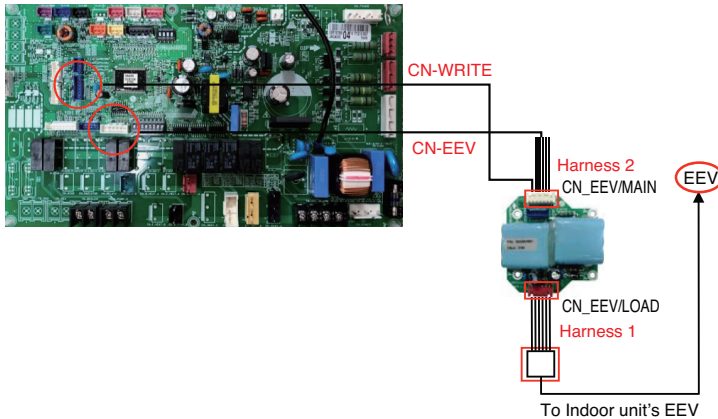

WARNING:

- The wire should not be exposed to the outside otherwise it may leads to the malfunction of the independent power kit due to wire damage.
- Wrong wiring also causes the malfunction of the independent power kit or damage to it.
- Power should be supplied more than 20 minutes continuously in order to operate the independent power kit correctly. Otherwise, the independent power kit can not fully close the EEV due to the lack of the charging power.



For more detailed information, refer to the installation manual of Independent Power Module.

6. System Set-Up

As **Hydro Kit**(For Medium Temperature) is designed to satisfy various installation environment, it is important to set up system correctly. If not configured correctly, improper operation or degrade of performance can be expected.

DIP Switch Setting

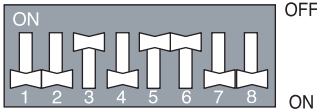

- Turn off electric power supply before setting DIP switch. There is risk of electric shock.
- Always set DIP switch #6 to ON.
- If DIP switch is not set as below, the unit may not operate properly.

x : OFF ● : On

Description	DIP switch setting								Function	Default
	1	2	3	4	5	6	7	8		
Group Control	x								Master	○
	●								Slave	
Installation Scene		x	x						Floor heating only	
		●	x						Floor heating + Hot water + solar booster	
		x	●						Floor heating + Hot water	○
		●	●						Hot water only	
Emergency operation				x					High temperature operation	○
				●					Low temperature operation	
Water pump control					x				Water pump controlled with Hydro Kit	
					●				Water pump NOT controlled with Hydro Kit	○
Antifreeze operation mode						●	x		Normal operation mode (connect short key)	○
						●	●		Antifreeze operation mode (disconnect short key)	
Thermostat connection								x	Thermostat NOT installed	○
								●	Thermostat installed	

※ short key

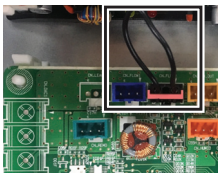

CAUTION:

After adding brine(Anti-freeze) only the Water circuit can be set to Anti Freeze mode. Otherwise the product may malfunction due to freezing and bursting.

WARNING:

Do not add brine(Anti-freeze) during Hot water mode.

Group Control Setting

Group Control

- Wired remote controller 1 + Many of **Hydro Kit**

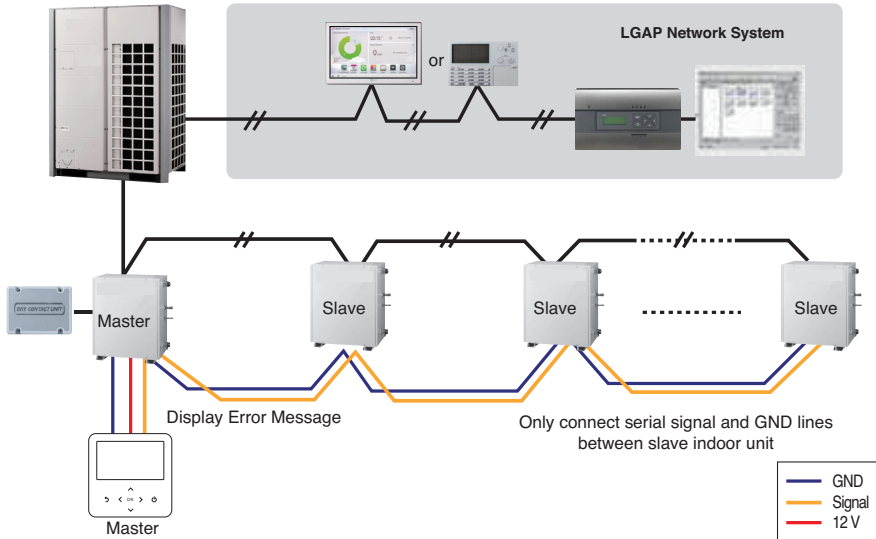

- DIP Switch in PCB

① Master Setting

- No. 1 Off

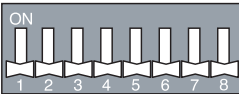

② Slave Setting

- No. 1 On

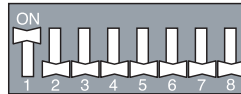

- It is possible to connect 16 indoor units(Max) by one wired remote controller.
Set only one indoor unit to Master, set the others to Slave.
- You can connect all the types of 2nd generation indoor units .
- It is possible to use wireless remote controller at the same time.
- It is possible to connect Dry Contact and Central controller at the same time.
 - The Master indoor unit is possible to recognize Dry Contact and Central Controller only.
 - In case of Central controller and Group controller at the same time, it is possible to connect standard 2series indoor units or later since Feb. 2009.
 - In case of Central controller setting, the Central controller can control indoor units after setting only the address of master indoor unit.
 - Slave indoor unit will be operated like master indoor unit.
 - Slave indoor unit can not be individually controlled by Central controller.
 - Some remote controller can't perform with Dry Contact and Central controller at the same time.
So contact us further information about it.



CAUTION:

- Indoor unit(Hydro Kit)'s group setting is possible which connected same outdoor unit.
 - To install Master and Slave indoor unit, the DIP Switch setting should be same.
 - Group control is not possible between hydro kit and air conditioner.
 - Group control is not possible between mid temperature hydro kit and high temperature hydro kit.
5. In case that the indoor unit has an abnormal problem an error code will be displayed on the wired remote controller.
With the exception of the indoor unit with the error, you can control each indoor unit individually.
6. In case of Group Control, it is possible to use following functions.
- Selection of operation options (operation/stop/mode/set temperature)
 - It is not possible at some functions.
- * Master/Slave setting of indoor units be set possible using a PCB DIP Switch.
- * It can be the cause of malfunctions when there is no setting of master and slave.

Accessories for group control setting

- Accessories for group control setting

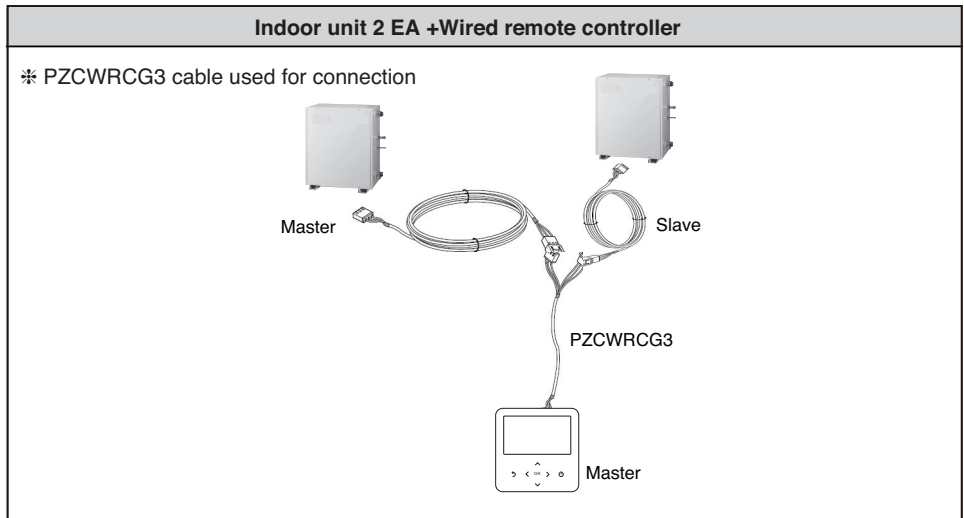

NOTICE**Emergency Operation****• Definition of terms**

- **Trouble** : a problem which can stop system operation, and can be resumed temporally under limited operation without certificated professional's assist.
- **Error** : problem which can stop system operation, and can be resumed ONLY after certificated professional's check.
- **Emergency mode** : temporary heating operation while system met Trouble.

• Objective of introducing 'Trouble'

- Not like airconditioning unit, **Hydro Kit** is generally operated in whole winter season without any system stopping.
- If system found some problem, which is not critical to system operating for yielding heating energy, the system can temporarily continue in emergency mode operation with end user's decision.

• Classified Trouble

- Trouble is classified two levels according to the seriousness of the problem : Slight Trouble and Heavy trouble
- **Slight Trouble** : Sensor trouble.
- **Heavy trouble** : Compressor cycle trouble.
- **Option Trouble** : a problem is found for option operation such as water tank heating. In this trouble, the troubled option is assumed as if it is not installed at the system.

• Emergency operation level

- When the system is faced with trouble, it stops and waits for user's decision : Calling service center or starting emergency operation.
- To start emergency operation, user simply push ON / OFF button once more.
- Two different levels are prepared for emergency operation : High temperature cycle and low temperature cycle.
- In emergency operation mode, user can not adjust target temperature.

	DIP Switch (No.4)	Target Leaving Water Temperature	Target Room Air Temperature	Target Sanitary Water (DHW) Temperature
High temperature cycle	OFF	50°C(122°F)	24°C(75°F)	50°C(122°F)
Low temperature cycle	ON	30°C(86°F)	19°C(66°F)	50°C(122°F)

- **Duplicated trouble : Option trouble with Slight or Heavy trouble**

If option trouble is occurred with slight (or heavy) trouble at the same time, the system puts higher priority to slight (or heavy) trouble and operates as if slight (or heavy) trouble is occurred.

Therefore, sometimes sanitary water heating can be impossible in emergency operation mode.

When sanitary water is not warming up while emergency operation, please check whether the sanitary water sensor and related wiring are connected well or not.

- **Emergency operation is not automatically restarted after main electricity power is reset.**

In normal condition, the unit operating information is restored and automatically restarted after main electricity power is reset.

But in emergency operation, automatic re-start is prohibited to protect the unit.

Therefore, user must restart the unit after power reset when emergency operation has been running.

Installer Setting

How to enter installer setting mode

- In the menu screen, press [←,→(left/right)] button to select the setting category, and press [^ (up)] button for 3 seconds to enter the password input screen for the installer setting.
- Input the password and press [OK] button to move to the installer setting list.

! CAUTION

The installer setting mode is the mode to set the remote controller's detail function. If the installer setting mode is incorrectly set, it may cause product failure, user's injury, or property damage. It must be set by the installation specialist with the installation license, and if it is installed or changed without installation license, all problems caused will be the responsibility of the installer, and may void the LG warranty.

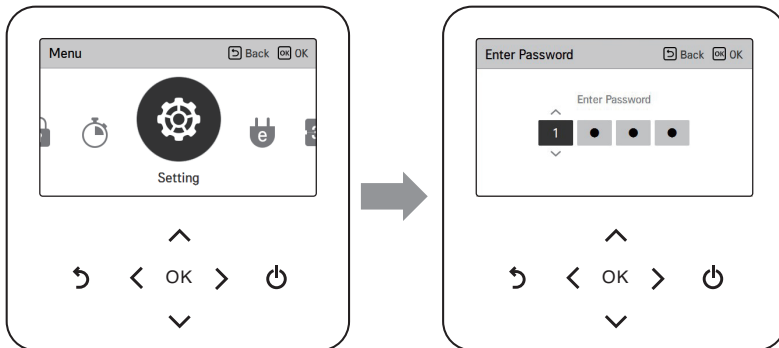

* Installer setting password

Main screen → menu → setting → service → RMC version information → SW Version

Example) SW version : 1.00.1 a

In the above case, the password is 1001.

Note:

Some categories of the installer setting menu may not be available depending on the product function or the menu name may be different.

Summary

- You can set the product user functions.
- Some functions may not be displayed/operated in some product types.

Test	Description
Test Run	Checking whenever Amount of refrigerant is normal
3 Minutes Delay	Factory use only
Remote sensor active	Connection information about remote air sensor
Temp. sensor selection	Selection for setting temperature as air temperature or leaving water temperature
Dry Contact Mode	Setting dry contact auto start option.
Central Control Address	When Central Controller is installed, address assigning is set by this function.
Override Master/Slave	Override master/slave selection function is to prevent the unit's different mode operation. If the unit is set as the slave, it blocks a change of opposite operating mode(cooling/heating).
Pump test run	Checking whether water circulation is normal.
Air cooling set temp.	Adjusting range of 'Setting Air Temperature' in cooling mode
Water cooling set temp.	Adjusting range of 'Setting Leaving Water Temperature' in cooling mode
Air heating set temp.	Adjusting range of 'Setting Air Temperature' in heating mode
Water heating set temp.	Adjusting range of 'Setting Heating Flow Temperature' in heating mode
DHW set temp.	Adjusting range of 'Setting DHW tank Heating Flow Temperature' in domestic hot water tank heating mode
Cooling / Heating only mode	Setting the Operation mode lock
Water supply off temp. during cooling	Determine leaving water temperature when the unit is turned off. This function is used for preventing condensation on the floor in cooling mode
Outdoor temp. for auto mode	Setting outdoor Min/Max temperature for auto mode
Indoor air temp. for auto mode	Setting indoor Min/Max temperature for auto mode
LWT for auto mode	Setting heating flow Min/Max temperature for auto mode
Tank disinfection setting 1	Setting start/maintain time for pasteurisation
Tank disinfection setting 2	Setting pasteurisation temperature
Tank setting1	Setting start temperature for operation
Tank setting2	Setting maintain temperature for operation
DHW time setting	Determine follow time duration : operation time of domestic hot water tank heating, stop time of domestic hot water tank heating, and delay time of DHW tank heater operating
Night time power setting	Setting to distinguish power-on time type of model using night power
TH on/off Variable, heating air	Setting Thermal on/off Air Temperature gap in heating mode
TH on/off Variable, heating water	Setting Thermal on/off Water Temperature gap in heating mode
TH on/off Variable, cooling air	Setting the step value to adjust air temperature gap in cooling mode
TH on/off Variable, cooling water	Setting the step value to adjust water temperature gap in cooling mode
TH on/off Variable, DHW	Setting the step value to adjust DHW temperature gap in heating mode
Heating temp. setting	Setting the temperature of entering or leaving water in heating mode
Cooling temp. setting	Setting the temperature of entering or leaving water in cooling mode
Pump setting in heating	Setting options of water pump operation / delay time in heating mode
Pump setting in cooling	Setting options of water pump operation / delay time in cooling mode
Forced operation	Setting of Forced product operation

Test	Description
CN_CC	Setting Dry Contact installation set.
Pump frequency setting(LPM)	Setting water flow rate.
HS Model Setting	Setting whether to install HS Model or not
Refrigerant Leak Sensor	Setting whether to install Refrigerant Leak detector or not
IDU Address Verification	Displaying the IDU address.
CN_EXT	Setting whether to install IO Module or not
ODU Function Master	Setting ODU Function Master
Low Noise Mode Priority	Setting whether to control in IDU or in ODU
Mode Standby / Priority Cooling	Setting mode standby When Master IDU is cooling mode.
Password Initialization	Password Initialization
Data logging	Data logging

*Temp. = Temperature
 *Sanitary water = Domestic Hot Water



CAUTION:

There is no disinfection function in Hydro Kit.

So, external control equipment should be installed for disinfection function.

Common Setting

• 3 Test Run

Test run should be performed when charging the additional refrigerant is required. The unit must be operated in Cooling mode when the refrigerant is being charged. Test run instantly makes the unit operate in Cooling mode for 18 minutes.

Note: • If you press any kind of button during this mode, Test Run mode will be finished.

- After the unit operates under Test run mode for 18 minutes, it will be turned off automatically

• 3 Minutes Delay

Factory use only.

• Remote sensor active

If user connects remote air sensor to control the product by room air temperature, the connection information should be notified to the product.

Note : If remote air sensor is connected but this function code is not set correctly, the product can not be controlled by room air temperature.

• Temp. sensor selection

The product can be operated according to air temperature or leaving water temperature. The selection for setting temperature as air temperature or leaving water temperature is determined.

Note : Air temperature as setting temperature is ONLY available when Remote Air Sensor Connection is enabled and Remote Air Sensor Connection is set as 02.

• Dry Contact Mode

This function allows the Dry contact-indoor unit operate under Auto Run mode or Manual mode with remote control panel.

• Central Control Address

When Central Controller is installed, address assigning is set by this function.

- Setting value: 00 ~ FF (Hex)

first two digits: Central control group number

last two digits: Central control indoor unit number

• Override Master/Slave

Override master/slave selection function is to prevent the unit's different mode operation. If the unit is set as the slave, it blocks a change of opposite operating mode(cooling/heating).

* To use override master/slave selection function is only possible when units are connected in series to the outdoor unit.

• Pump test run

After water pipe work is done, Water Pump Test Run mode should be performed to check whether water circulation is normal.

Temperature Range Setting

• Air cooling set temp.

Determine cooling setting temperature range when air temperature is selected as setting temperature.

NOTICE

Only available when remote air temperature sensor is connected.

- Accessory PQRSTA0 should be installed.
- Also, Remote air sensor connection should be set properly.

• Water cooling set temp

Determine cooling setting temperature range when leaving water temperature is selected as setting temperature.

NOTICE

Water condensation on the floor

- While cooling operation, it is very important to keep leaving water temperature higher than 16 °C. Otherwise, dew condensation can be occurred on the floor.
- If floor is in humid environment, do not set leaving water temperature below 18 °C.

NOTICE

Water condensation on the radiator

- While cooling operation, cold water may not flow to the radiator. If cold water enters to the radiator, dew generation on the surface of the radiator can be occurred.

• Air heating set temp.

Determine heating setting temperature range when air temperature is selected as setting temperature.



CAUTION:

Only available when remote air temperature sensor is connected.

- Accessory PQRSTA0 should be installed.
- Also, Remote air sensor connection should be set properly.

• Water heating set temp

Determine heating setting temperature range when leaving water temperature is selected as setting temperature.

• DHW set temp.

Determine heating setting temperature range of water tank leaving water.

NOTICE

Only available when DHW tank feature is installed.

- DHW tank and DHW tank kit should be installed.
- DIP switch No. 2 and 3 should be set properly.

• Cooling / Heating only mode

Set the Operation mode lock when Multi V Indoor unit is used only cooling mode in summer and Hydro Kit is used only heating in winter.

Temperature Control Parameter Setting

• Water supply off temp. during cooling

Determine leaving water temperature when the product is turned off. This function is used for preventing condensation on the floor in cooling mode.

- Stop temp. : cut-off temperature. Stop temp. is valid when FCU is installed.
- FCU : determines if FCU is installed or not.
- Example : If Stop temp. is set as '10' and FCU is 'Use' and actually FCU is NOT installed in the water loop, the unit stop operation in cooling mode when the leaving water temperature is below 10 °C.
- Example : If Stop temp. is set as '10' and FCU is 'Not use' and actually FCU is installed in the water loop, the Stop temp. is not used and the unit do NOT stop operation in cooling mode when the leaving water temperature is below 10 °C.

NOTICE

FCU Installation

- If FCU is used, related 2way valve should be installed and connected to the indoor unit PCB.
- If FCU is set as 'Not use' but FCU or 2way valve is NOT installed, the unit can do abnormal operation.

• Tank disinfection setting 1, 2

Disinfection operation is special DHW tank operation mode to kill and to prevent growth of viruses inside the tank.

- Disinfection active : Selecting enable or disable of disinfection operation.
- Start date : Determining the date when the disinfection mode is running.
- Start time : Determining the time when the disinfection mode is running.
- Max temp. : Target temperature of disinfection mode.
- Duration time : Duration of disinfection mode.

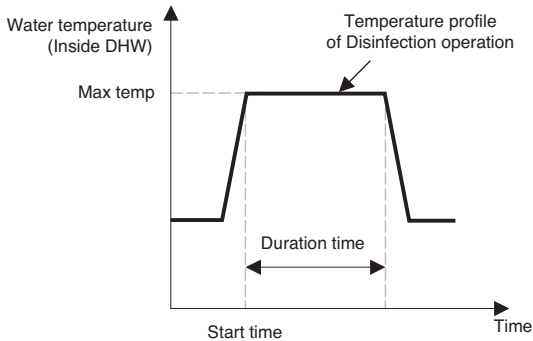

NOTICE

Vales of Tank disinfection setting

- If Disinfection active is set as 'Not use', that is 'disable disinfection mode', Start date and Start time is not used.
- When Disinfection active is set as 'Use', that is 'enable disinfection mode', Start date is displayed at the position of Disinfection active and Start time is displayed at the position of Start date.

NOTICE

DHW heating should be enable

- If Disinfection active is set as 'Not use', that is 'disable disinfection mode', Start date and Start time is not used.
- When Disinfection active is set as 'Use', that is 'enable disinfection mode', Start date is displayed at the position of Disinfection active and Start time is displayed at the position of Start date.

• **Tank setting 1, 2**

Descriptions for each parameters are as following.

- Min temp. : temperature gap from Max outdoor temp.
- Max outdoor temp. : maximum temperature generated by AWHP compressor cycle.
- Example : If Min temp. is set as '5' and Max outdoor temp. is set as '48', then Session A (see the graph) will be started when the water tank temperature is below 45 °C.... If temperature is above 48 °C..., then Session B will be started.

- Hysteresis : temperature gap from target DHW temperature. This value is required to frequent On and Off of water tank heater.
- Heating priority : Determining heating demand priority between DHW tank heating and under floor heating.
- Example : If user's target temperature is set as '70' and Hysteresis is set as '3', then the water tank heater will be turned off when the water temperature is above 73 °C. The water tank heater will be turned on when the water temperature is below 70 °C.
- Example : If Heating priority is set as 'DHW', that means heating priority is on DHW heating, DHW is heated by AWHP compressor cycle and water heater. In this case the under floor can not be heated while DHW heating. On the other hand, if the Heating priority is set as 'Floor heating', that means heating priority is on under floor heating, DHW tank is ONLY heated by water heater. In this case the under floor heating is not stopped while DHW is heated.

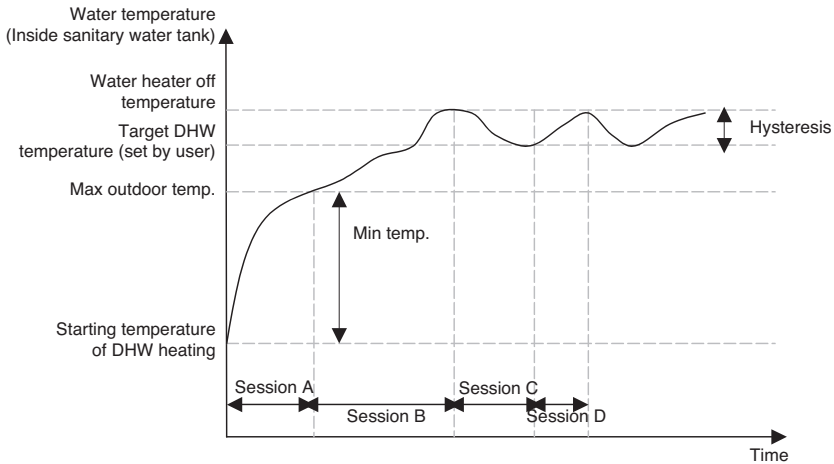

- Session A : Heating by AWHP compressor cycle and water heater
- Session B : Heating by water heater
- Session C : No heating (Water heater is Off)
- Session D : Heating by water heater

NOTICE

DHW heating does not operate when it is disabled.

• DHW time setting

Determine following time duration : operation time of DHW tank heating, stop time of DHW tank heating, and delay time of DHW tank heater operating.

- Active time : This time duration defines how long time DHW tank heating can be continued.
- Stop time : This time duration defines how long time DHW tank heating can be stopped. It is also regarded as time gap between DHW tank heating cycle.
- Boost heater delay time : This time duration defines how long time DHW tank heater will not be turned on in DHW heating operation.

• **Night time power setting**

Setting to distinguish power-on time type of model using night power.

Type	Setting range
0	0H
1	2/8H
2	7H
3	24H (This function is selectable when receiving night power timer function from indoor unit)

• **TH on/off Variable, heating air**

Setting Thermal on/off Air Temperature gap in heating mode

	Th On	Th Off
0	-0.5°C	1.5°C
1	4°C	6°C
2	2°C	4°C
3	-1°C	1°C

• **TH on/off Variable, heating water**

Setting Thermal on/off Water Temperature gap in heating mode

	Th On	Th Off
0	-2°C	2°C
1	-6°C	4°C
2	-2°C	4°C
3	-1°C	1°C

• **TH on/off Variable, cooling air**

Setting the step value to adjust air temperature gap in cooling mode

	Th On	Th Off
0	0.5°C	-0.5°C
1	6°C	4°C
2	4°C	2°C
3	1°C	-1°C

• **TH on/off Variable, cooling water**

Setting the step value to adjust water temperature gap in cooling mode

	Th On	Th Off
0	0.5°C	-0.5°C
1	6°C	-4°C
2	2°C	-4°C
3	1°C	-1°C

• **TH on/off Variable, DHW**

Setting the step value to adjust DHW temperature gap in heating mode

	Th On	Th Off
0	-2°C	2°C
1	-6°C	4°C
2	-2°C	4°C
3	-1°C	1°C

• **Forced operation**

This function is disable the logic of Water Pump Off Ability that drives the water pump by itself after 20 hours of continuous use

• Pump frequency setting(LPM)

Setting water flow rate

Determine the difference between target inlet water temperature and target outlet water temperature from water flow rate.

Setting value	Water flow rate (l/min)	
	ARNH10GK2A4	ARNH04GK2A4
50	20~22	45~50
55	23~24	51~55
60	25~26	56~60
65	27~28	61~65
70	29~30	66~70
75	31~32	71~75
80	33~34	76~80
85	35~37	81~85
90	38~39	86~90
92	40	91~92

• CN_EXT

Determining the purpose of CN_EXT

Setting value: 0 ~ 5 step Indoor CN-EXT port setting

- 0: default
- 1: Simple operation on / off
- 2: Dry contact (simple contact)
- 3: Emergency stop only for indoor unit
- 4: Reattachment / absence
- 5: Emergency stop of all indoor units (It can be set only when indoor unit has emergency stop function)

• ODU Function Master

- 1) Setting of outdoor unit function Master status
 - Low noise operation control subject can be set
 - Low noise operation time setting
 - Defrost mode can be set
- 2) Setting of outdoor unit function Slave status
 - No noise operation control subject setting
 - No noise operation time setting
 - No defrost mode setting

• **Low Noise Mode Priority**

Setting whether to control in IDU or in ODU

1) Setting outdoor management of low noise operation

It is controlled by outdoor unit according to switch setting value of low noise operation of outdoor unit PCB.

Function Setting - Low noise operation time menu is inactivated

2) Setting remote control management of low noise operation

Low noise operation switch setting of outdoor unit PCB is ignored.

Function Setting - Low noise operation time menu is activated.

7. Test Run

Caution before Operation Test

- Check whether water flow is smoothly supplied.
- Check whether the flow switch properly operates.
- Check whether the connection status is good.
- Check whether the power cable and communication cable are completely connected.
- Check whether it is 2.0 mΩ or above, when insulation resistance between the terminal block and ground is measured with DC mega tester (DC 500V).
- Never check insulation resistance for the connector of the control board.

Operation Test of Water Pipe

Category	Status	Check point
Flow Switch Error	CH14	Check whether operation of water pipe is normal.
		Check for the block inside water pipe.
		(Strainer cleaning, valve locked, valve malfunction, air remaining, etc.)
		Check problem with flow switch.
		(Flow switch disorder, untold operation, disconnection, etc.)

Troubleshooting

If **Hydro Kit** operates not properly or it does not start operation, please check following list.

Error No.	Error Type	Main Reasons
01	Air temperature sensor error	Air temperature sensor disconnection or short circuit
02	Gas side temperature sensor error	Gas side temperature sensor disconnection or short circuit
03	No communication between wired remote controller & indoor unit	The remote controller does not receive the signal from indoor unit during specific time
05	Indoor unit & outdoor unit communication error	No signal communication between indoor unit & outdoor unit
06	Liquid side temperature sensor error	Liquid side temperature sensor disconnection or short circuit
08	Water tank temperature sensor error	Water tank temperature sensor disconnection or short circuit
09	Indoor unit EEPROM error	Communication between the micro-processor & the EEPROM / Error due to EEPROM damage
13	Solar thermal temperature sensor error	Solar thermal temperature sensor disconnection or short circuit
14	Flow switch error	Abnormal working of flow switch
15	Water pipe overheated	Water outlet temperature is above 85°C (185°F)
16	Water inlet & outlet temperature sensor error	Water inlet & outlet temperature sensor disconnection or short circuit simultaneously
17	Water inlet temperature sensor error	Water inlet temperature sensor disconnection or short circuit
18	Water outlet temperature sensor error	Water outlet temperature sensor disconnection or short circuit
187	Hydro-Kit P.HEX bursting error	Inlet water temperature is below 5 degree or water temperature error during defrosting operation.

Airborne Noise Emission

The A-weighted sound pressure emitted by this product is below 70 dB.

- The noise level can vary depending on the site.

The figures quoted are emission level and are not necessarily safe working levels. Whilst there is a correlation between the emission and exposure levels, this cannot be used reliably to determine whether or not further precautions are required. Factor that influence the actual level of exposure of the workforce include the characteristics of the work room and the other sources of noise, i.e. the number of equipment and other adjacent processes and the length of time for which an operator exposed to the noise. Also, the permissible exposure level can vary from country to country. This information, however, will enable the user of the equipment to make a better evaluation of the hazard and risk.

Limiting concentration

Limiting concentration is the limit of Freon gas concentration where immediate measures can be taken without hurting human body when refrigerant leaks in the air. The limiting concentration shall be described in the unit of kg/m³ (Freon gas weight per unit air volume) for facilitating calculation

Limiting concentration: 0.44 kg/m³(R410A)

■ Calculate refrigerant concentration

Refrigerant concentration = $\frac{\text{Total amount of replenished refrigerant in refrigerant facility (kg)}}{\text{Capacity of smallest room where indoor unit is installed (m}^3\text{)}}$

Model Designation

